

ROTEL

**Owner's Manual
Manuel de l'utilisateur
Bedienungsanleitung
Manuale di Istruzioni
Manual de Instruccioness**

RCD-961

Stereo Compact Disc Player

Lecteur de disque compact

Stereo-CD-Player

Lettore CD

Reproductor de Discos Compactos

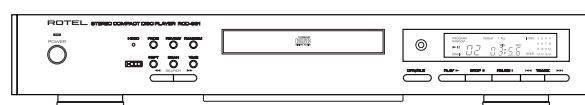



APPLICABLE FOR USA, CANADA OR WHERE APPROVED FOR THE USAGE

CAUTION: TO PREVENT ELECTRIC SHOCK, MATCH WIDE BLADE OF PLUG TO WIDE SLOT. INSERT FULLY.

ATTENTION: POUR EVITER LES CHOCS ELECTRIQUES, INTRODUIRE LA LAME LA PLUS LARGE DE LA FICHE DANS LA BORNE CORRESPONDANTE DE LA PRISE ET POUSSER JUSQU'AU FOND.

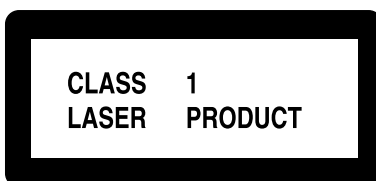
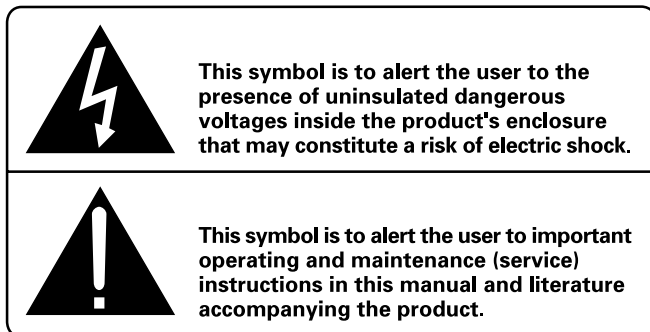

IMPORTANT FOR LASER PRODUCTS

1. CLASS 1 LASER PRODUCT
2. **DANGER:** Visible laser radiation when open and interlock failed or bypassed. Avoid direct exposure to beam.
3. **CAUTION:** Do not open the top cover. There are no user serviceable parts inside the player; leave all servicing to qualified service personnel.

WARNING!

To reduce the risk of electrical shock, fires, etc.:

1. Do not remove screws, covers or cabinet.
2. Do not expose the unit to rain or moisture.
3. Do not touch the power cord or plug with wet hands.

WARNING: There are no user serviceable parts inside. Refer all servicing to qualified service personnel.

WARNING: To reduce the risk of fire or electric shock, do not expose the unit to moisture or water. Do not allow foreign objects to get into the enclosure. If the unit is exposed to moisture, or a foreign object gets into the enclosure, immediately disconnect the power cord from the wall. Take the unit to a qualified service person for inspection and necessary repairs.

Read all the instructions before connecting or operating the component. Keep this manual so you can refer to these safety instructions.

Heed all warnings and safety information in these instructions and on the product itself. Follow all operating instructions.

Clean the enclosure only with a dry cloth or a vacuum cleaner.

You must allow 10 cm or 4 inches of unobstructed clearance around the unit. Do not place the unit on a bed, sofa, rug, or similar surface that could block the ventilation slots. If the component is placed in a bookcase or cabinet, there must be ventilation of the cabinet to allow proper cooling.

Keep the component away from radiators, heat registers, stoves, or any other appliance that produces heat.

The unit must be connected to a power supply only of the type and voltage specified on the rear panel of the unit.

Connect the component to the power outlet only with the supplied power supply cable or an exact equivalent. Do not modify the supplied cable in any way. Do not attempt to defeat grounding and/or polarization provisions. Do not use extension cords.

Do not route the power cord where it will be crushed, pinched, bent at severe angles, exposed to heat, or damaged in any way. Pay particular attention to the power cord at the plug and where it exits the back of the unit.

The power cord should be unplugged from the wall outlet if the unit is to be left unused for a long period of time.

Immediately stop using the component and have it inspected and/or serviced by a qualified service agency if:

- The power supply cord or plug has been damaged.
- Objects have fallen or liquid has been spilled into the unit.
- The unit has been exposed to rain.
- The unit shows signs of improper operation
- The unit has been dropped or damaged in any way

Place the unit on a fixed, level surface strong enough to support its weight. Do not place it on a moveable cart that could tip over.



CAUTION	- LASER RADIATION WHEN OPEN. DO NOT STARE INTO BEAM.
ATTENTION	- RAYONNEMENT LASER EN CAS D'OUVERTURE. NE PAS REGARDER DANS LE FAISCEAU.
VORSICHT	- LASERSTRAHLUNG. WENN ABDECKUNG GEÖFFNET, NICHT IN DEN STRAHL BLICKEN.
ADVARSEL	- LASERSTRÅLING VED ÅBNING. SE IKKE IND I STRÅLEN.
ADVARSEL	- LASERSTRÅLING NÅR DEKSEL ÅPNES. STIRR IKKE INN I STRÅLEN.
VARNING	- LASERSTRÅLNING NÅR DENNA DEL ÄR ÖPPNAD. STRÅR EJ IN I STRÅLEN.
VARO!	- AVATTAESSA OLET ALTTIINA LASERSÄTEILYLLE. ÄLÄ TUJOTA SÄTEESEEN.
注意	- 当打开这里会出现激光, 请不要直视激光。
注意	- ここを開くとレーザー光が出ます。 レーザー光をのぞき込まないでください。

Figure 1: Controls and Connections
Commandes et branchements
Bedienelemente und Anschlüsse
Comandi E Collegamenti
Controles y Conexiones

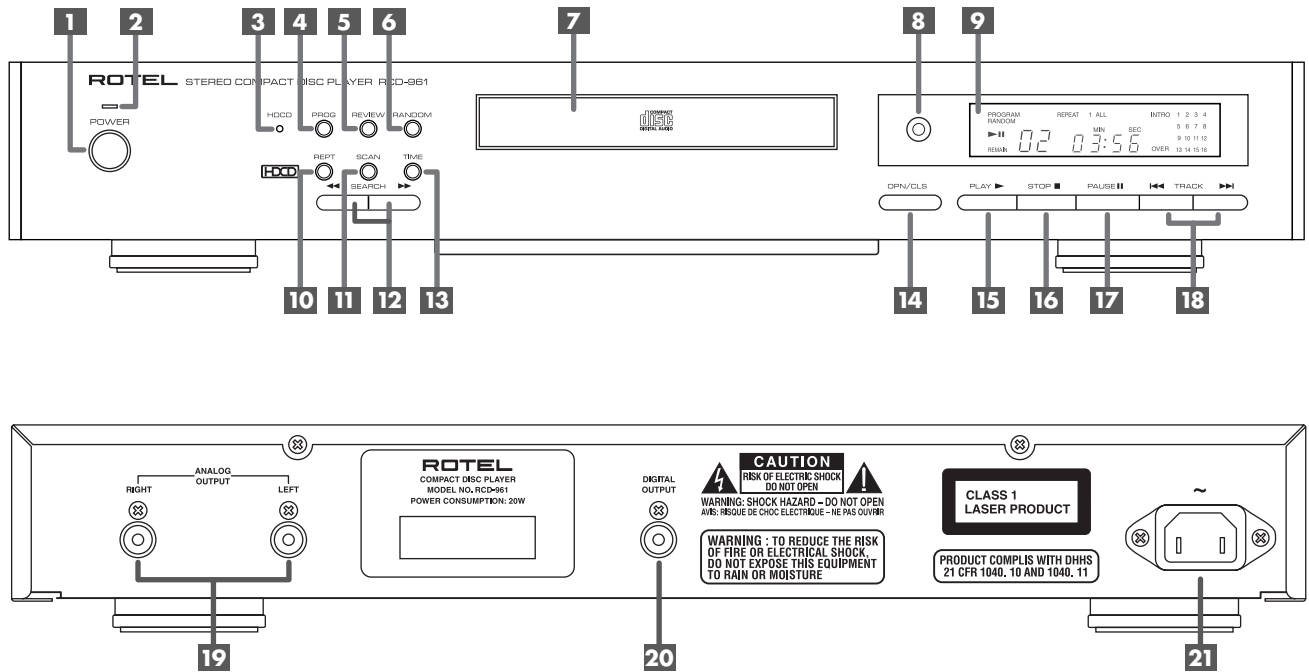

Figure 2: RR-D94 Remote Control
Télécommande RR-D94
Fernbedienung RR-D94
Comando A Distanza RR-D94
Mando a Distancia RR-D94

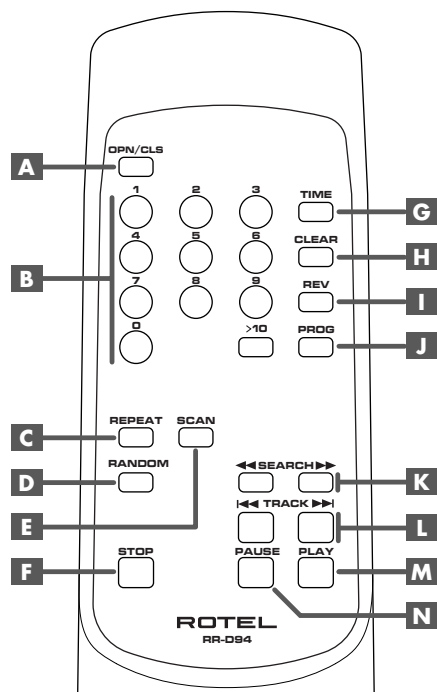

Figure 3: Analog Outputs
Sorties analogiques
Analoge Ausgänge
Uscite Analogiche
Salidas Analógicas

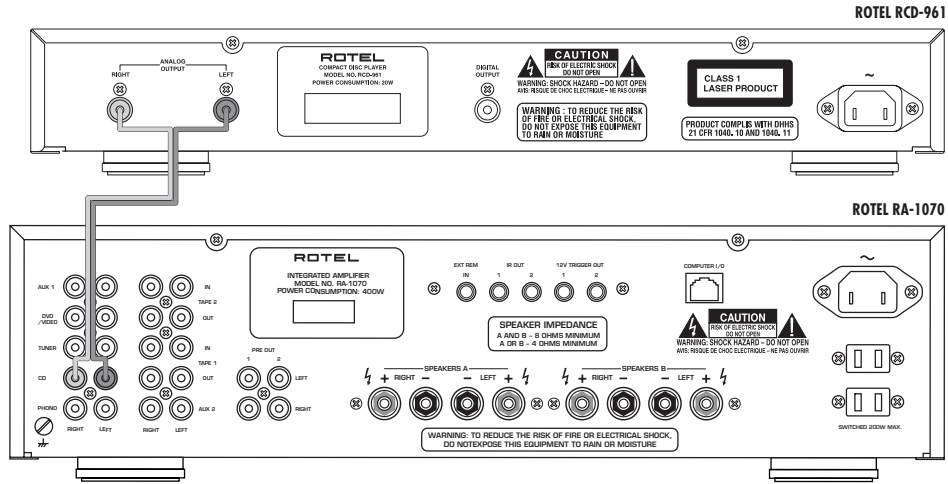
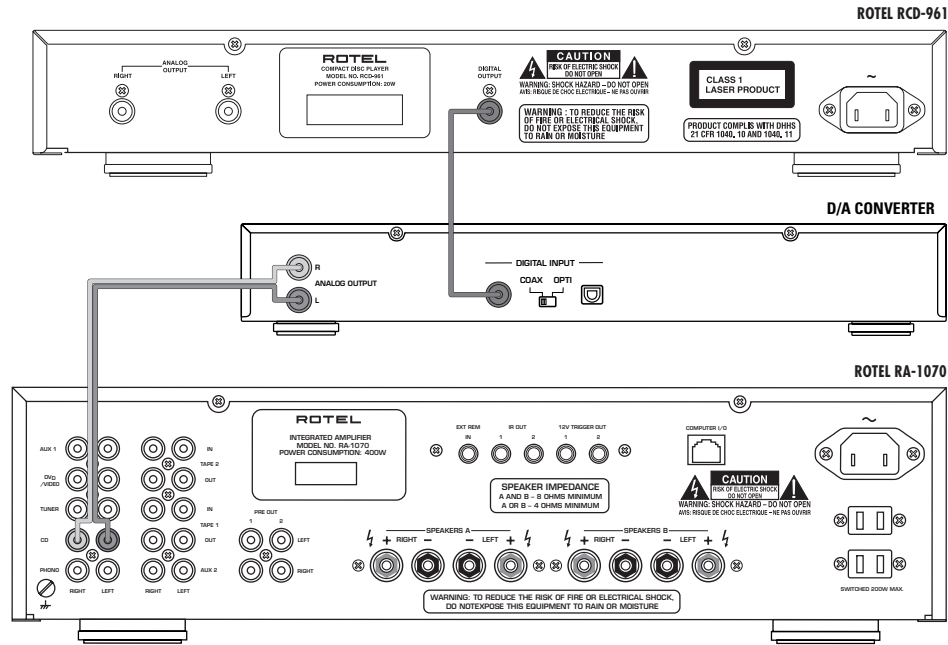

Figure 4: Digital Outputs
Sorties numériques
Digitalausgang
Uscite Digitali
Salidas Digitales



Contents

Figure 1: Controls and Connections	3
Figure 2: RR-D94 Remote Control	3
Figure 3: Analog Outputs	4
Figure 4: Digital Outputs	4
About Rotel	5
Getting Started	5
A Few Precautions	5
Placement	5
Control Identification	5
AC Power and Control	6
AC Power Input 21	6
Power Switch 1 and Power Indicator 2	6
Output Connections	6
Analog Outputs 19	6
Digital Output 20	6
Operation	6
Infrared Remote Control 8	6
Display 9	6
Disc Drawer 7	6
Transport Control Buttons	7
OPEN/CLOSE Button 14 A	7
PLAY Button 15 M	7
STOP Button 16 F	7
PAUSE Button 17 N	7
TRACK Buttons 18 L	7
DIRECT ACCESS Buttons B	7
SEARCH Buttons 12 K	7
Additional Features	7
HDCD® 3	7
PROGRAM Button 4 J	8
REVIEW Button 5 I	8
CLEAR Button H	8
RANDOM Button 6 D	8
REPEAT Button 10 C	8
SCAN Button 11 E	8
TIME Button 13 G	9
Troubleshooting	9
Power Indicator Is Not Lit	9
Fuse Replacement	9
No Sound	9
Specifications	9

About Rotel

A family whose passionate interest in music led them to manufacture high fidelity components of uncompromising quality founded Rotel over 40 years ago. Through the years that passion has remained undiminished and the family goal of providing exceptional value for audiophiles and music lovers regardless of their budget, is shared by all Rotel employees.

The engineers work as a close team, listening to, and fine tuning each new product until it reaches their exacting musical standards. They are free to choose components from around the world in order to make that product the best they can. You are likely to find capacitors from the United Kingdom and Germany, semi conductors from Japan or the United States, while toroidal power transformers are manufactured in Rotel's own factory.

Rotel's reputation for excellence has been earned through hundreds of good reviews and awards from the most respected reviewers in the industry, who listen to music every day. Their comments keep the company true to its goal - the pursuit of equipment that is musical, reliable and affordable.

All of us at Rotel, thank you for buying this product and hope it will bring you many hours of enjoyment.

Getting Started

Thank you for purchasing the Rotel RCD-961 Stereo Compact Disc Player. Its precision transport is back up by an 18-bit equivalent, multi-level Delta-Sigma D/A converter with 8x oversampling and HDCD®. These features, combined with Rotel's Balanced Design, ensure the RCD-961 will deliver the highest level of audio performance. When used in a high-quality audio system, your Rotel CD player will provide years of enjoyment.

A Few Precautions

Please read this manual carefully. In addition to installation and operating instructions, it provides valuable information on various RCD-961 system configurations as well as general information that will help you get optimum performance from your system. Please contact your authorized Rotel dealer for answers to any questions you might have. In addition, all of us at Rotel welcome your questions and comments.

Save the RCD-961 shipping carton and all enclosed packing material for future use. Shipping or moving the RCD-961 in anything other than the original packing material may result in severe damage that is not covered by the warranty.

Fill out and send in the owner's registration card packed with the RCD-961. Also be sure to keep the original sales receipt. It is your best record of the date of purchase, which you will need in the event warranty service is required.

Placement

Use common sense when placing the RCD-961 in a cabinet or when stacking other equipment. Make sure that the shelf or cabinet can support its weight. Do not stack heavy components on top of the RCD-961. Avoid placing the unit where it may be subject to excessive heat such as on top of a large power amplifier or near a heat register. For best performance, avoid placing the unit where it may be subject to vibration, such as near a speaker.

Control Identification

The cover of this manual has a fold out panel that shows illustrations of the front and rear panels and the RR-D94 remote control. Each item in the illustrations is identified with a call out in a gray box. Through out this manual the items referred to in the text are identified by the corresponding call out. The items on the front and rear panels are identified with a number call out, such as **1**. The items on the remote control are labeled with a letter call out, such as **A**.

HDCD®, **HDCD®**, *High Definition Compatible Digital®* and *Pacific Microsonics™* are either registered trademarks or trademarks of *Pacific Microsonics, Inc. in the United States and/or other countries.* *HDCD system manufactured under license from Pacific Microsonics, Inc. This product is covered by one or more of the following: In the USA: 5,479,168, 5,638,074, 5,640,161, 5,808,574, 5,838,274, 5,854,600, 5,872,531 and in Australia: 669114. Other patents pending.*

AC Power and Control

AC Power Input 21

Your RCD-961 is configured at the factory for the proper AC voltage in the country where you purchased it (either 115 volts or 230/240 volts). The AC line configuration is noted on a decal on the back panel.

Note: Should you move your CD player to another country, it may be possible to reconfigure it for use on a different line voltage. Do not attempt to perform this conversion yourself. Opening the enclosure of the RCD-961 exposes you to dangerous voltages. Consult a qualified service person or the Rotel factory service department for information.

The RCD-961 should be plugged directly into a 2-pin polarized wall outlet or into the switched outlet on another component in your audio system. Do not use an extension cord.

Be sure the power switch on the front panel of the RCD-961 is turned off (in the "out" position). Then, connect the supplied power cord to the AC power receptacle on the rear of the unit and the AC power outlet.

If you are going to be away from home for an extended period of time such as a month-long vacation, it is a sensible precaution to unplug your CD player (as well as other audio and video components) while you are away.

Power Switch 1 and Power Indicator 2

The power switch is located on the front panel of your CD player. To turn the CD player on, push the switch in. The LED indicator above the switch and the Display will light up, indicating that the CD player is turned on. To turn the CD player off, push the button again and return it to the "out" position.

Note: If you are using a switched outlet to turn on and off your CD player, you should leave the power switch in the "on" position. When AC power is applied to the unit, it will power up in fully active mode.

Output Connections

The RCD-961 gives you a choice of two different kinds of output connections — an analog output signal from the built-in D/A converter for use with conventional analog audio components and a coax digital output which provides an unprocessed digital data signal for use with outboard D/A converters or digital processors.

Note: To prevent loud noises that neither you nor your speakers will appreciate, make sure the CD player is turned off when you make any signal connections.

Analog Outputs 19

[See Figure 3 for wiring illustration]

A pair of standard RCA jacks supplies an analog output signal from the RCD-961 to the source inputs of an audio preamplifier, integrated amplifier, or receiver.

Select high quality audio interconnect cables. Connect the left channel output of the RCD-961 to the left channel source input on the preamplifier or other component. Connect the right output of the RCD-961 to the right channel source input on the preamplifier or other component.

Digital Output 20

[See Figure 4 for wiring illustration]

If you are using an outboard D/A converter or other digital processor, you will need an unprocessed digital data stream from the RCD-961, taken before the built-in D/A converter. This signal is supplied by the RCD-961's back-panel digital output jack. Using a standard 75 ohm coax digital cable, connect the RCD-961's coax digital output to the coax digital input connector on the outboard D/A converter.

Operation

The RCD-961 can be operated using its front panel buttons or from corresponding buttons on the supplied infrared remote control. Specific instructions for each of these controls are detailed below. Most of the buttons are duplicated on the front panel and on the IR remote control. However, there are a few exceptions where the buttons are only available on one or the other. These exceptions are noted in the instructions.

Infrared Remote Control 8

Before using the IR remote control, it is necessary to install two "UM-4/AAA" batteries (supplied). Remove the plastic cover on the back of the IR remote, install the batteries (observing the + and - polarity indications), and reinstall the cover.

To use the IR remote control, aim it at the IR sensor 8 located in the Display area on the front panel of the RCD-961.

Display 9

A lighted Display on the front panel of the RCD-961 provides useful information about the status of the unit, activation of special features, and track/time information for the disc being played. Each of these indicators is described in the detailed operating instructions that follow.



Disc Drawer 7

A motor-driven disc drawer, located in the center of the RCD-961, slides out to accept a compact disc and retracts to play the disc. Place the compact disc in the drawer label-side up. Make sure the disc is properly centered in the tray. The drawer can be closed in two ways: pushing the OPN/CLS button or pushing the PLAY button.

Transport Control Buttons

These buttons provide basic control functions for the disc transport mechanism. Except where noted, all functions are available on the RCD-961 front panel and the IR remote control. The numbered call outs

OPEN/CLOSE Button 14 A

When the transport disc drawer is closed, pressing this button automatically opens the drawer. To close the drawer, press this button again. The drawer can also be closed by pressing the PLAY button

When the drawer is open, the Display will read "OPEN". When it is closed with no disc, the display will read "NO DISC". When the drawer closes with a disc inserted, the Display will indicate the number of tracks on the disc and the total time of the disc in minutes and seconds.

PLAY Button 15 M

Press the PLAY button to start playing the disc. If the disc drawer is open, it will close automatically. The number of the track being played and the elapsed time will be shown in the display, along with the PLAY indicator. Normally, the disc will start playing with the first track. However, you can select a different track using the TRACK buttons or the DIRECT ACCESS buttons (see below) before pressing the PLAY button to start playing a different selection.

STOP Button 16 F

This button stops a disc that is playing and resets the player, i.e. if play is resumed, the disc will start over from the first track. Pressing the STOP button twice quickly in succession cancels any programmed selections (see below).

PAUSE Button 17 N

This button is used to temporarily suspend play. The disc continues to spin and play will be resumed from the current position. The PAUSE indicator will light in the Display. To resume playing the disc, press the PAUSE button again or press the PLAY button.

TRACK Buttons 18 L

These buttons are used to select tracks on the disc. When a disc is playing, pressing the right TRACK button advances to the beginning of the next track. Pressing the left TRACK button returns to the beginning of the current track. Pressing twice quickly in succession returns to the beginning of the previous track. The new track number appears in the Display.

These buttons are also used to select a track before pressing the PLAY button or when memorizing tracks for the PROGRAM play mode (see below). These selections are made by continuously pressing the TRACK buttons until the desired track is reached.

In PROGRAM mode, the TRACK buttons advance or reverse to the next track in the memorized selection list.

DIRECT ACCESS Buttons B

(remote only)

These eleven numeric buttons (labeled 1 through 10 and >10) are used to directly access a track from the IR remote control instead of stepping through the tracks using the TRACK buttons.

The first ten tracks on a disc can be selected by pressing the corresponding button. For example, to play the third track, press the 3 button on the remote control.

When accessing track numbers greater than 10, press the >10 button followed by the track number. For example, to select track 12, press the >10 button followed by the 1 button and then the 2 button.

The number of the selected track will appear in the main numeric area at the center of the Display.

There is also a four by four matrix of track numbers (1 – 16) located at the right side of the display. This display indicates all of the tracks on the disc. If there are more than 16 tracks on the disc, all of the digits will light accompanied by the word OVER, regardless of which track is playing. This matrix is independent of the main numeric area of the Display, which will always indicate the currently playing track, even if above 16.

The DIRECT ACCESS buttons may also be used to memorize tracks in PROGRAM mode (see below).

SEARCH Buttons 12 K

These buttons fast forward or fast reverse through the currently playing disc as long as they are pressed. While the buttons are pressed, you will hear high-speed audio. Releasing the buttons returns to PLAY mode.

Additional Features

These convenience features add extra functionality to the RCD-961, including the ability to play high-definition HDCD discs, to memorize a group of tracks to be played, to repeat a disc, program, or track over and over, to play the tracks on a disc in random order, to automatically play the first 10 seconds of each track, and to select from several available time displays.

HDCD® 3

HDCD® is an encoding technique that allows a CD to have greater effective dynamic range, reduced distortion, and increased detail. When playing HDCD encoded discs, the RCD-961 can reproduce as much as 18-bit dynamic range. HDCD discs are identified by an HDCD logo on the package.

No user action is required to play an HDCD recording. The CD player automatically senses HDCD encoding and enables the circuitry. The HDCD LED on the front panel will light to indicate that an HDCD disc is being played.

PROGRAM Button 4 J

This button, labeled PROG, allows you to memorize as many as 20 tracks on the current disc for playback in a specific order. For example, you could instruct the RCD-961 to play track 5, followed by track 3, followed by track 8. To begin a program:

- 1 Insert a disc and press the OPEN/CLOSE button to close the drawer. The RCD-961 will read the contents of the disc.
- 2 Press the PROGRAM button on the front panel or the remote control. The PROGRAM indicator will light up in the Display, along with "P:00" indicating that the unit is waiting for the first track to be memorized.
- 3 To program tracks from the handheld remote control, enter the first track number using the DIRECT ACCESS buttons. Your selection will be memorized automatically and the Display indicator will change to "P:01", indicating that one track has been memorized. Continue entering the rest of your selections using the DIRECT ACCESS buttons. Note that there is no need to press the PROGRAM button as each selection is memorized as it is entered.
- 4 To program tracks from the front panel, select the first track number using the TRACK buttons. The track number and the program number in the display will flash for 3 seconds. While the display is flashing, press the PROGRAM button to memorize your selection. Note that once the flashing stops, you will no longer be able to memorize your selection. To memorize additional tracks, select them with the TRACK buttons, pressing the PROGRAM button after each selection.

Once you have memorized a play list, the RCD-961 remains in PROGRAM mode until you open the disc drawer or press the STOP button twice in succession. If you press the PLAY button, the memorized program will play instead of the entire disc, starting with the first selection in the memorized list.

When a PROGRAM has been memorized, most functions that would normally effect the entire disc operate on just the memorized program. For example, the TRACK buttons advance to the next track in the memorized program, not the next track on the disc. Likewise, the REPEAT button (see below) continuously plays the memorized program, not the entire disc.

REVIEW Button 5 I

This button is used to review the memorized tracks in PROGRAM mode. Press the button and the first memorized track number will appear in order in the Display, flashing for approximately five seconds. Pressing the REVIEW button again while the track number is flashing will continue the review sequence, showing the next memorized track. Continue pressing the REVIEW button to see the complete memorized track list.

If you do not press the REVIEW button while the track number is flashing, the review process is terminated and the unit resumes whatever mode it was in before you started to review, except that the last reviewed track number will remain active and shown in the display.

Note that you may remove a selection from the play list during the review procedure using the CLEAR button, as described below.

CLEAR Button I1

(remote only)

This button allows you to remove a track selection from the memorized program play list during the review procedure described above. Follow the review procedure until the desired track number is flashing. Then, instead of pressing the REVIEW button to continue, remove the displayed track by pressing the CLEAR button while the number is still flashing. You may then continue the review procedure.

RANDOM Button 6 D

This instructs the CD player to play tracks from the entire disc in random order. Once all of the selections have been played once, the disc will stop playing, unless the REPEAT Button (see below) has been engaged, in which case the random play will continue until the STOP button is pressed. When the RANDOM button is engaged, the word RANDOM appears in the Display.

REPEAT Button 10 C

This button allows you to repeat the current track or the entire disc continuously until the feature is cancelled by disengaging the REPEAT button or pressing STOP. The REPEAT button steps sequentially through the available options. Press the button once and the RCD-961 will repeat just the current track, displaying the indicators REPEAT 1 in the Display. Press the button a second time and the RCD-961 will repeat the entire disc, displaying REPEAT ALL in the Display. Press the button a third time to cancel the REPEAT function.

As noted above, REPEAT can be used in conjunction with the RANDOM play feature.

Note: The REPEAT function is automatically cancelled when the disc drawer is opened.

SCAN Button 11 E

This feature automatically plays the first ten seconds of each track on the disc (or the memorized program). To activate the feature, press the SCAN button. The word INTRO appears in the Display. To stop scanning and resume normal operation at the current track, press the SCAN button again or press the PLAY button.

TIME Button 13 G

Normally, the RCD-961 displays the elapsed time of the currently playing track. The TIME button allows you to step through two alternative time displays. Pressing the button once displays the time remaining in the current track, which counts down as the track continues playing. Pressing the button a second time displays the time remaining on the entire disc (or memorized program). Pressing the button a third time reverts to the standard elapsed time display. When the TIME feature is activated, the word REMAIN appears in the Display.

Troubleshooting

Most difficulties in audio systems are the result of incorrect connections, or improper control settings. If you encounter problems, isolate the area of the difficulty, check the control settings, determine the cause of the fault and make the necessary changes. If you are unable to get sound from the RCD-961, refer to the suggestions for the following conditions:

Power Indicator Is Not Lit

The Power Indicator and the basic items in the Display window should be lit whenever the RCD-961 is plugged into the wall power outlet and the Power button is pushed in. If it does not light, test the power outlet with another electrical device, such as a lamp. Be sure the power outlet being used is not controlled by a switch that has been turned off.

Fuse Replacement

If another electrical device works when plugged into the power outlet, but the Power Indicator and the Display still will not light when the RCD-961 is plugged into the wall outlet, it indicates that the internal power fuse may have blown. If you believe this has happened, contact your authorized Rotel dealer to get the fuse replaced.

No Sound

Check the cables between the RCD-961 and the amplifier inputs to be sure they are connected properly. Be sure the amplifier input that the RCD-961 is selected. Be sure the tape monitor system of the amplifier has not been activated. Check the wiring between the amplifier and the speakers.

Specifications

Total Harmonic Distortion + Noise	0.0045% @ 1kHz
Intermodulation Distortion	0.0045% @ 1kHz
Frequency Response (± 0.5 dB)	20-20,000 Hz
Channel Balance	± 0.5 dB
Phase Linearity	± 0.5 degree
Channel Separation	> 98 dB @ 1kHz
Signal to Noise Ratio	> 100dB
Dynamic Range	> 96 dB
Digital to Analog Converters	18 bit equivalent, multi-level Delta-Sigma DAC with 8x oversampling digital filter and HDCD
Speed Accuracy, Wow & Flutter	Quartz Crystal Precision
Output Impedance	100 Ohms
Digital Output	0.5 Volt, Peak to Peak
Load Impedance	75 Ohms
Power Requirements	
USA Version	AC 115V, 60 Hz
European Version:	AC 230V, 50 Hz
Power Consumption	20 Watts
Dimensions (W, H, D)	17 ³ / ₈ x 27 ⁷ / ₈ x 12 ⁷ / ₁₆ inches 440 x 72 x 316 mm
Weight (net)	5.4 kg, 11.9 lb.

All specifications are accurate at the time of printing. Rotel reserves the right to make improvements without notice.

Rotel and the Rotel HiFi logo are registered trademarks of The Rotel Co, Ltd., Tokyo, Japan. , HDCD® High Definition Compatible Digital® and Pacific Microsonics™ are either registered trademarks or trademarks of Pacific Microsonics, Inc, in the United States and /or other countries.

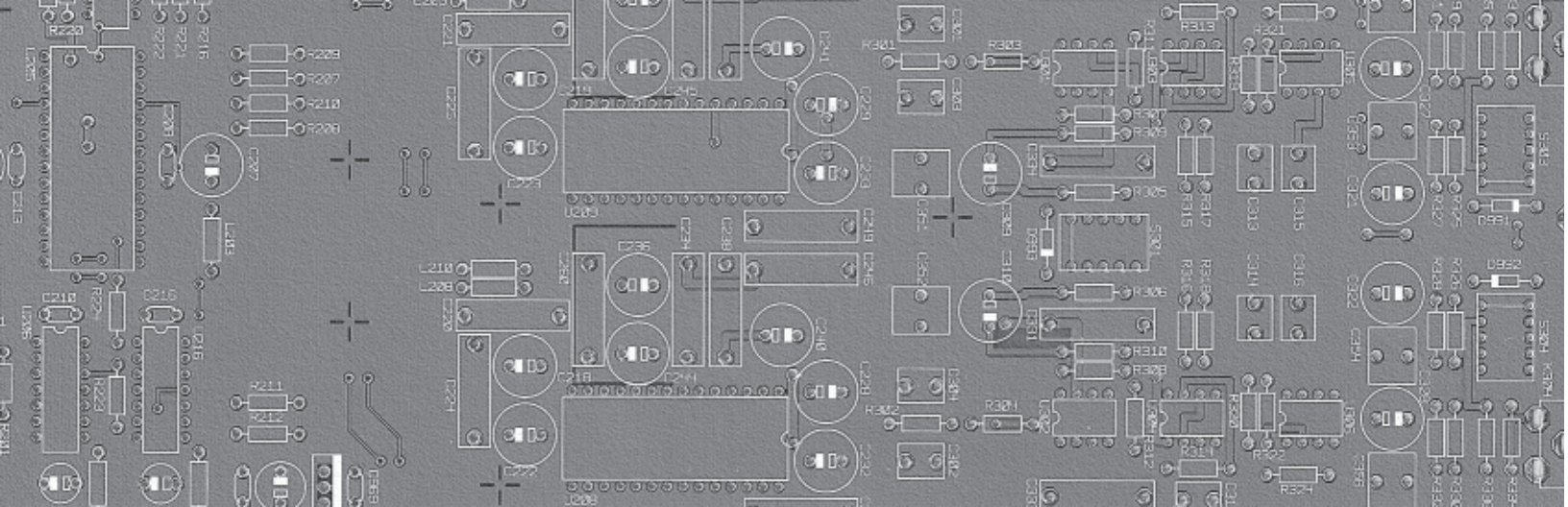

ROTEL

The Rotel Co. Ltd.

10-10 Shinsen-Cho
Shibuya-Ku
Tokyo 150-0045
Japan
Phone: +81 3-5458-5325
Fax: +81 3-5458-5310

Rotel of America

54 Concord Street
North Reading, MA 01864-2699
USA
Phone: +1 978-664-3820
Fax: +1 978-664-4109

Rotel Europe

Meadow Road
Worthing, West Sussex BN11 2RX
England
Phone: +44 (0)1903 524 813
Fax: +44 (0)1903 524 831

Rotel Deutschland

Kleine Heide 12
D-33790 Halle/Westf.
Germany
Phone: +49 05201-87170
Fax: +49 05201-73370

www.rotel.com